

# LED Downlighting

Energy-Efficient Recessed Lighting  
April 2016



CSL's LED Eco-Downlight sets the industry standard for excellence in downlight functionality and dependability, and continues to innovate the downlight space by creating and developing new product offerings. Our newest fixtures, available in all three Eco-Downlight sizes, offer sustainable, low-power-use solutions to enhance any downlight project.

Eco-Downlight's durable housing construction encases energy-efficient LED fixtures, available with 5", 3", and 1" apertures, with light sources that meet L70 standards.

5" Eco-Downlight	2
5" Housings – LPD	5
5" Housings – Standard	4
5" Specialty Trims & Accessories Standard & LPD	6
5" Trims – Standard & LPD	8
3" Adjustable Trims – Standard IC / LPD IC	18
3" Eco-Downlight	10
3" Housings – LPD	13
3" Housings – Shallow Plenum	15
3" Housings – Standard	12
3" Specialty Trims & Accessories – Standard / LPD / Shallow Plenum	14
3" Trims – Standard / LPD / Shallow Plenum	16
3" Xicato® Accessories, Trims & Adjustable Trims	23
3" Xicato® Eco-Downlight	20
3" Xicato® Housings	22
1" Mini Accessories – Standard & LPD	31
1" Mini Adjustable Trims – Standard IC / LPD IC	30
1" Mini Eco-Downlight	24
1" Mini Housings – LPD	27
1" Mini Housings – Standard	26
1" Mini Trims – Standard & LPD	28
Index	33
Ordering Examples for Dimming Options:	
5" Standard Eco-Downlight	8
3" Standard Eco-Downlight	15
3" Xicato Eco-Downlight	22
1" Mini Standard Eco-Downlight	29

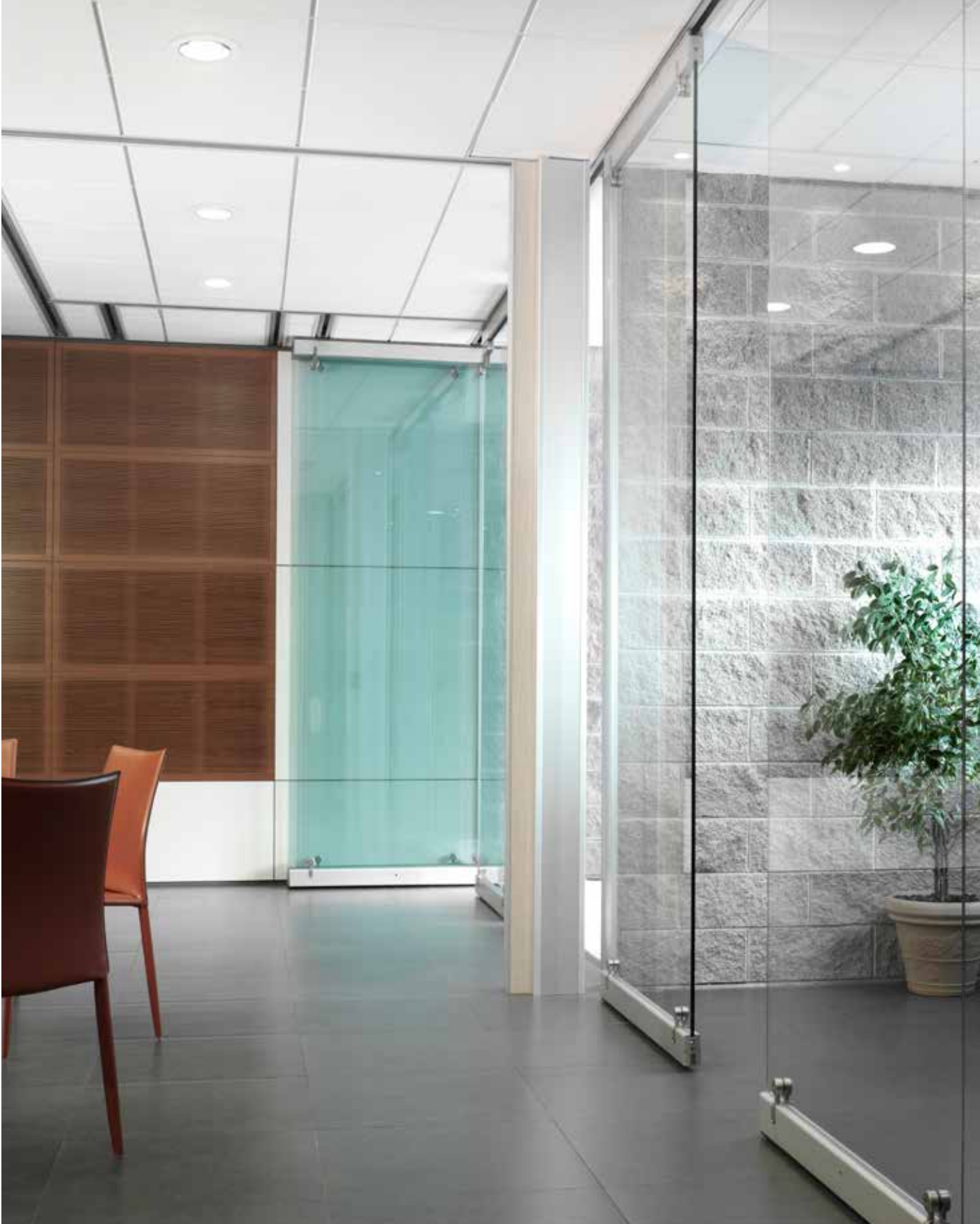



# 5" Eco-Downlight



CSL's standard 5" Eco-Downlight is characterized by excellence in performance and energy efficiency, while offering a range of features including:

- Four color temperature choices
- Compatibility with INC (incandescent/triac), ELV and 0-10V dimming to 10%
- Multiple optics included
- Stylish and decorative trims and trim finishes, many of which are Title 24 tested and compliant



To expand our variety of downlighting options, CSL introduces our 5" Eco-Downlight Low Power Density (LPD) fixture. The Eco-Downlight LPD is ultra-efficient, with a power output of almost 50% less than our standard 5" downlight, while featuring signature CSL high-performance capabilities and fixture options.



# 5" Standard Housings

## 5" Standard New Construction (Non-IC)

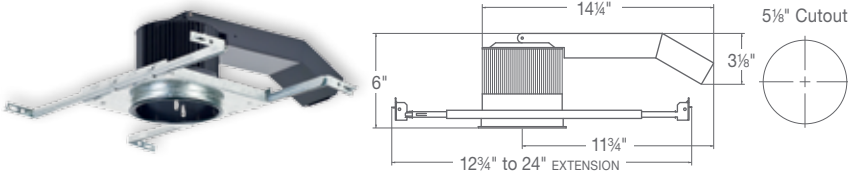

### 120-277V 38W Integral Driver

50/60 Hz, INC/ELV/0-10V Universal dimming

EDL5-NC-27-1	LED, 2,700°K ±50°K, CRI 90, 2815 lm
EDL5-NC-30-1	LED, 3,000°K ±50°K, CRI 90, 3012 lm
EDL5-NC-35-1	LED, 3,500°K ±50°K, CRI 90, 3012 lm
EDL5-NC-40-1	LED, 4,000°K ±50°K, CRI 80, 3700 lm

## 5" Standard Remodel/Retrofit

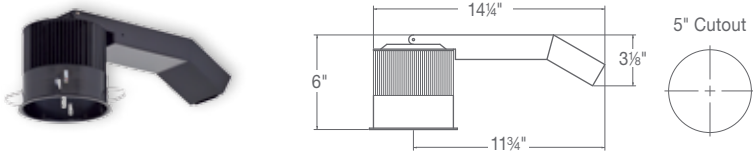

### 120-277V 38W Integral Driver

50/60 Hz, INC/ELV/0-10V Universal dimming

EDL5-RM-27-1	LED, 2,700°K ±50°K, CRI 90, 2815 lm
EDL5-RM-30-1	LED, 3,000°K ±50°K, CRI 90, 3012 lm
EDL5-RM-35-1	LED, 3,500°K ±50°K, CRI 90, 3012 lm
EDL5-RM-40-1	LED, 4,000°K ±50°K, CRI 80, 3700 lm

## 5" Standard IC/Airtight

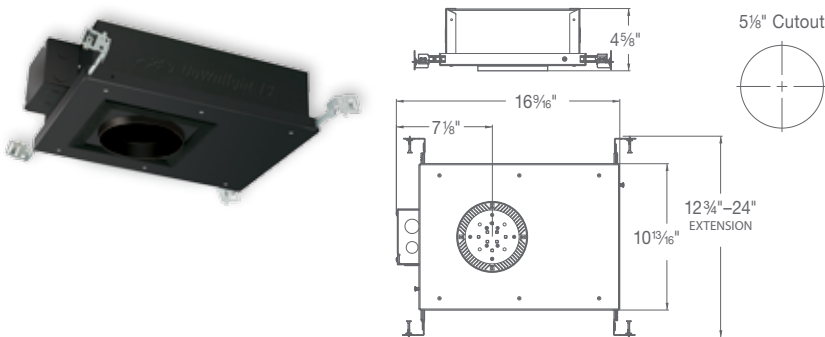

### 120-277V 38W Integral Driver

50/60 Hz, INC/ELV/0-10V Universal dimming

EDL5-IC-27-1	LED, 2,700°K ±50°K, CRI 90, 2815 lm
EDL5-IC-30-1	LED, 3,000°K ±50°K, CRI 90, 3012 lm
EDL5-IC-35-1	LED, 3,500°K ±50°K, CRI 90, 3012 lm
EDL5-IC-40-1	LED, 4,000°K ±50°K, CRI 80, 3700 lm

**WARNING:** Polycell spray-in foam insulation requires setback of 3" from all sides and top of housing.

### Fixture

- Integral 120-277V input LED driver, 38W output, 85% efficient, 0.90 power factor
- Field-replaceable light engine and driver
- UL/C-UL listed for damp location

### LEDs

- High-performance COB LEDs:
  - 38W, 2,700°K, ±50, CRI 90, 2815 lm
  - 38W, 3,000°K, ±50, CRI 90, 3012 lm
  - 38W, 3,500°K ±50, CRI 90, 3012 lm
  - 38W, 4,000°K ±50, CRI 80, 3700 lm
- 2-step binning process
- 50,000 hours at 70% lumen maintenance (L70)
- LM79 test results available at [csllighting.com](http://csllighting.com)

### Dimming

- Standard dimming compatible with INC (incandescent/triac), ELV or 0-10V dimmers to 10%
  - Lutron dimming options available\*:
    - L1 – Lutron A Series Hi-Lume 2-Wire
    - L2 – Lutron Eco System 5 Series
    - L3 – Lutron Hi-Lume H Series Fade-to-Black
    - L4 – Lutron A Series Hi-Lume 3-Wire
  - EldoLED dimming options available\*:
    - EL1 – EldoLED DALI
    - EL2 – EldoLED 0-10V
- \* See ordering example on page 8.

### Housing/Heat Sink

- 30°, 50° and 80° optics included; optional optic: Very Narrow 10°
- Extruded aluminum heat sink with black anodized finish

### New Construction and Remodel/Retrofit

- Cold-rolled steel housing with black powder-coat finish
- Mounting:
  - New Construction:** Galvanized-steel plaster frame, adjustable hanger bars
  - Remodel/Retrofit:** Black oxide-coated, heat-treated spring steel mounting clips (included)
- Adjusts vertically to accommodate ceiling thicknesses from 1/2" to 1 1/2"
- Aluminum junction box with two 1/2" trade-size knockouts

### IC/Airtight

- Aluminum airtight housing with black powder-coat finish
- Galvanized steel adjustable hanger bars
- Accommodates ceiling thicknesses up to 1"
- Cold-rolled steel junction box with black anodized finish and four 1/2" and four 3/4" trade-size knockouts

# 5" LPD Housings (Low-Power Density)

## 5" LPD New Construction (IC/Airtight Rated\*)

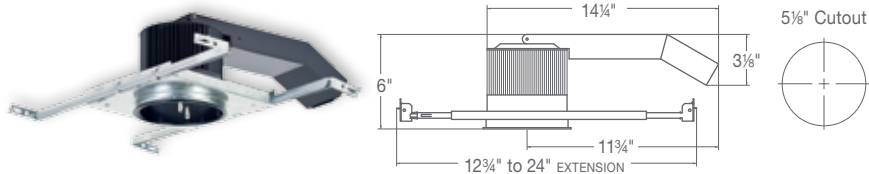

### 120V 20W Integral Driver

50/60 Hz, INC/ELV/0-10V Universal dimming

**EDL5-NC-27-1-LPD** LED, 2,700°K ±50°K, CRI 90, 1500 lm

**EDL5-NC-30-1-LPD** LED, 3,000°K ±50°K, CRI 90, 1600 lm

### Fixture

- Integral 120V input LED driver, 20W output, 90% efficient, 0.99 power factor
- Field-replaceable light engine and driver
- UL/C-UL listed for damp location



### LEDs

- High-performance COB LEDs:
  - 20W, 2,700°K, ±50, CRI 90, 1500 lm
  - 20W, 3,000°K, ±50, CRI 90, 1600 lm
- 2-step binning process
- 50,000 hours at 70% lumen maintenance (L70)
- LM79 test results available at [cslighting.com](http://cslighting.com)
- Compatible with INC (incandescent/triac) or ELV dimmers to 10%; 120V only

### Housing/Heat Sink

- 50° optic included; optional optics:
  - 10° Very Narrow, 30° Narrow, 80° Wide Flood
- Extruded aluminum heat sink with black anodized finish

### New Construction and Remodel

- Cold-rolled steel housing with black powder-coat finish
- Mounting:
  - New Construction:** Galvanized steel, adjustable hanger bars
  - Remodel/Retrofit:** Includes black oxide-coated, heat-treated spring steel mounting clips
- Adjusts vertically to accommodate ceiling thicknesses from 1/2" to 1 1/2"
- Aluminum junction box with two 1/2" trade-size knockouts

## 5" LPD Remodel/Retrofit (IC/Airtight Rated\*)

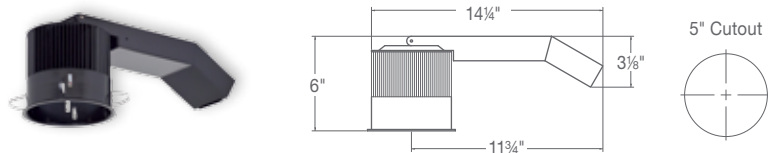

### 120V 20W Integral Driver

50/60 Hz, INC/ELV/0-10V Universal dimming

**EDL5-RM-27-1-LPD** LED, 2,700°K ±50°K, CRI 90, 1500 lm

**EDL5-RM-30-1-LPD** LED, 3,000°K ±50°K, CRI 90, 1600 lm

## 5" LPD IC/Airtight

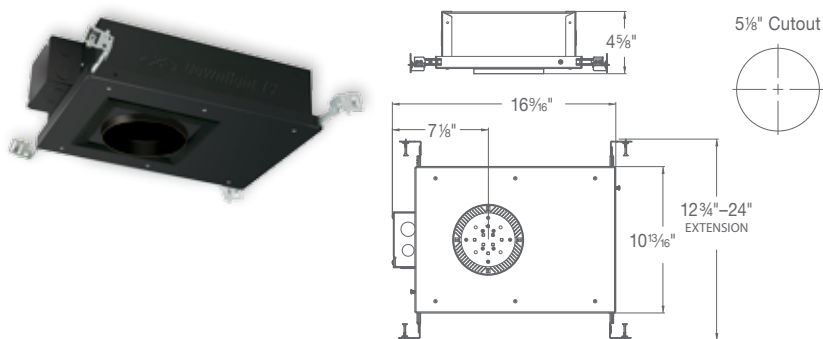

### 120V 20W Integral Driver

50/60 Hz, INC/ELV/0-10V Universal dimming

**EDL5-IC-27-1-LPD** LED, 2,700°K ±50°K, CRI 90, 1500 lm

**EDL5-IC-30-1-LPD** LED, 3,000°K ±50°K, CRI 90, 1600 lm

### IC/Airtight

- Aluminum airtight housing with black powder-coat finish
- Galvanized steel adjustable hanger bars
- Accommodates ceiling thicknesses up to 1"
- Cold-rolled steel junction box with black powder-coat finish and four 1/2" and four 3/4" trade-size knockouts

\* IC/Airtight option for EDL5-NC and EDL5-RM requires gasket accessory (EDL5-AT-GSKT).

**WARNING:** Polycell spray-in foam insulation requires setback of 3" from all sides and top of housing.

# 5" Specialty Trims & Accessories

## 5" Standard & LPD

### EDL5-5000 Series – Round Trimless Reflectors

			
<b>EDL5-5000-1</b>	<b>EDL5-5001-1</b>	<b>EDL5-5002-1</b>	<b>EDL5-5003-1</b>
White Reflector	Satin Aluminum Reflector	Bronze Reflector	Black Reflector

### EDL5-5100 Series – Round Trimless Baffles

			
<b>EDL5-5100-1</b>	<b>EDL5-5101-1</b>	<b>EDL5-5102-1</b>	<b>EDL5-5103-1</b>
White Baffle	Satin Aluminum Baffle	Bronze Baffle	Black Baffle

### EDL5 Trimless Ring

<b>EDL5-RD-TR-1</b>
Round Trimless Ring (for use with IC housings only)



### EDL5-1700 Series – Wallwash Trims

			
<b>EDL5-1700-1</b>	<b>EDL5-1701-1</b>	<b>EDL5-1702-1</b>	
White	Satin Aluminum	Bronze	

### EDL5-1800 Series – Double Wallwash Trims

			
<b>EDL5-1800-1</b>	<b>EDL5-1801-1</b>	<b>EDL5-1802-1</b>	
White	Satin Aluminum	Bronze	



### EDL5 Accessories

	
<b>EDL5-RD-FMA</b>	<b>EDL5-SQ-FMA</b>
Round Flush Mount Adapter (FMA) Ring	Round Flush Mount Adapter (FMA) Ring

<b>EDL5-10-OPTIC-1</b>	<b>EDL5-30-OPTIC-1</b>	<b>EDL5-50-OPTIC-1</b>
Very Narrow 10° Optic*	Narrow 30° Optic	Wide 50° Optic

<b>EDL5-80-OPTIC-1</b>	<b>EM-1000</b>	<b>EM-1002</b>
Wide Flood 80° Optic	25W LED Remote Inverter	10W EM Battery (field installable)

		
<b>EDL5-CL-1</b>	<b>EDL5-FT-1</b>	<b>EDL5-MP-1</b>
Clear Lens	Frosted Lens	Prismatic Lens

		
<b>EDL5-LN-1</b>	<b>EDL5-MHLDR-1</b>	<b>EDL5-AT-GSKT</b>
Linear Lens	Media Holder	Gasket (for use with LPD RM & NC housings only)



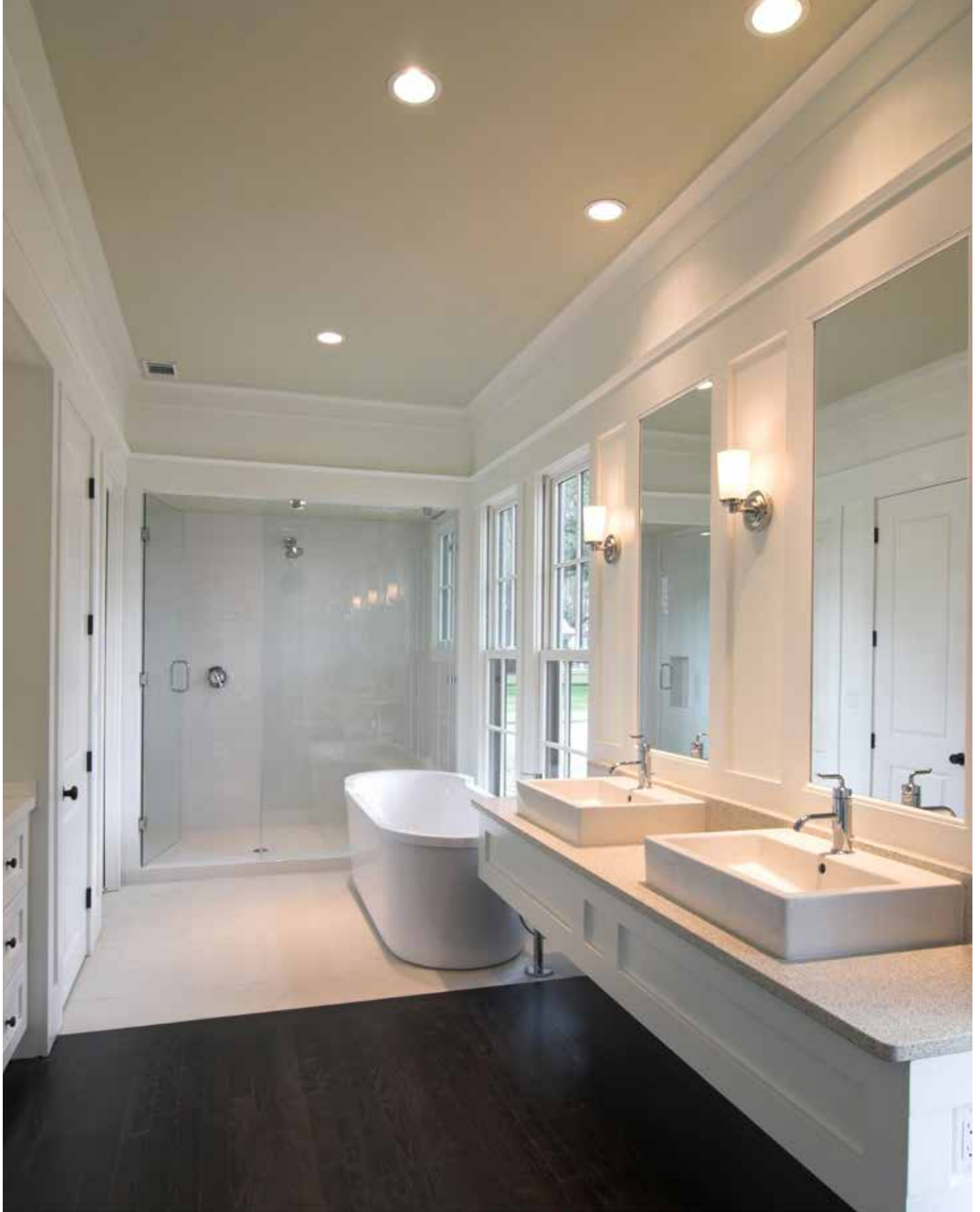

# 5" Standard & LPD Trims

## 5" Round

### EDL5-1000 Series



NUMBER	<b>EDL5-1000-1</b> ■	<b>EDL5-1001-1</b> ■	<b>EDL5-1002-1</b> ■	<b>EDL5-1003-1</b> ■	<b>EDL5-1004-1</b> ■
TRIM FINISH	White	White	Satin Aluminum	Satin Aluminum	White
REFLECTOR/BAFFLE	Clear Alzak Reflector	Black Alzak Reflector	Clear Alzak Reflector	Black Alzak Reflector	Haze Reflector



NUMBER	<b>EDL5-1005-1</b> ■	<b>EDL5-1006-1</b> ■
TRIM FINISH	Satin Aluminum	White
REFLECTOR/BAFFLE	Haze Reflector	White Reflector

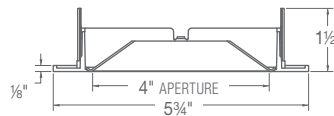

### EDL5-1100 Series



NUMBER	<b>EDL5-1100-1</b> ■	<b>EDL5-1101-1</b> ■	<b>EDL5-1102-1</b> ■
TRIM FINISH	White	White	Satin Aluminum
REFLECTOR/BAFFLE	White Baffle	Black Baffle	Black Baffle

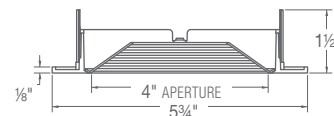

### EDL5-1200 Series



NUMBER	<b>EDL5-1200-1</b>
TRIM FINISH	White
REFLECTOR/BAFFLE	Shower Light

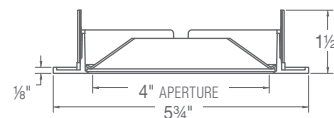

### Ordering Example: Dimming Options – 5" Standard Housings only

<b>EDL5</b>	-	<b>RM</b>	-	<b>27</b>	-	<b>1</b>	-	
FIXTURE		HOUSING TYPE		LIGHT COLOR		VERSION NUMBER		DIMMING OPTIONS
		<b>NC</b> – New Construction		<b>27</b> – 2700°K				<b>BLANK</b> – Standard Dimming
		<b>RM</b> – Remodel/Retrofit		<b>30</b> – 3000°K				<b>L1</b> – Lutron A Series Hi-Lume 2-Wire
		<b>IC</b> – Airtight		<b>35</b> – 3500°K				<b>L2</b> – Lutron Eco-System 5 Series
				<b>40</b> – 4000°K				<b>L3</b> – Lutron Hi-Lume H Series Fade-to-Black
								<b>L4</b> – Lutron A Series Hi-Lume 3-Wire
								<b>EL1</b> – EldoLED DALI
								<b>EL2</b> – EldoLED 0-10V



■ Indicates Title 24-compliant trim. Title 24-compliance applies to trims when used on Standard fixtures, not LPD.

### Materials

- Trim Rings: Diecast aluminum
- Reflectors and Baffles: Round – Spun aluminum and diecast aluminum  
Square – Diecast aluminum

### Finishes

- Standard Finishes: White Powder Coat, Satin Aluminum
- RAL color matching available (consult factory)

### Standard Accessories

- Optional optic: Very Narrow 10° (add -10 to trim part number when ordering 10° Optic – round trims only)
- Round and square FMA rings
- 25W LED Inverter
- 10W EM Battery (field installable)

### LPD Accessories

- Optional optics: Very Narrow 10°, Narrow 30°, Wide Flood 80° (add -10 to trim part number when ordering 10° Optic – round trims only)
- Round and square Flush Mount Adapter (FMA) rings
- Gasket (for IC option only)
- 25W LED Inverter
- 10W EM Battery (field installable)

## 5" Square

### EDL5-2000 Series

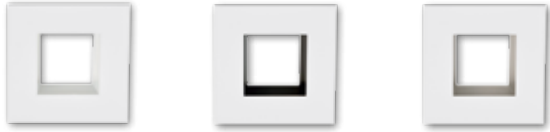

NUMBER	<b>EDL5-2000-1</b> ■	<b>EDL5-2001-1</b> ■	<b>EDL5-2002-1</b> ■
TRIM FINISH	White	White	White
REFLECTOR/ BAFFLE	White Reflector	Black Reflector	Haze Reflector

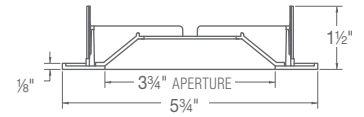

NUMBER	<b>EDL5-2003-1</b> ■	<b>EDL5-2004-1</b> ■
TRIM FINISH	Satin Aluminum	Satin Aluminum
REFLECTOR/ BAFFLE	Black Reflector	Haze Reflector

### EDL5-2100 Series



NUMBER	<b>EDL5-2100-1</b> ■	<b>EDL5-2101-1</b> ■	<b>EDL5-2102-1</b> ■
TRIM FINISH	White	White	Satin Aluminum
REFLECTOR/ BAFFLE	White Baffle	Black Baffle	Black Baffle

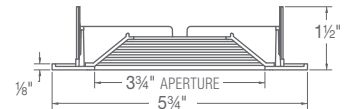

### EDL5-2200 Series



NUMBER	<b>EDL5-2200-1</b>
TRIM FINISH	White
REFLECTOR/ BAFFLE	Shower Light

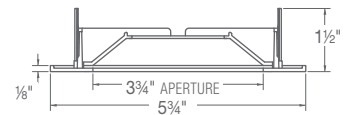

■ Indicates Title 24-compliant trim. Title 24-compliance applies to trims when used on Standard fixtures, not LPD.



# 3" Eco-Downlight



Known for its LED efficiency and superior illumination, CSL's standard 3" Eco-Downlight is our most popular downlight fixture. It offers an array of features, including four choices of color temperature (excludes Xicato), multiple included optics, and expanded dimming options, and is further enhanced with stylish and decorative trims, many of which are Title 24 tested and compliant.

Expanding choices for downlighting efficacy and style, CSL presents a trio of versatile new additions to our 3" Eco-Downlight offerings:

**3" Low Power Density (LPD) –**

Eco-Downlight LPD leads its list of impressive features with a power output almost 50% less than our standard LED downlights.

**3" Xicato®** – The Xicato Eco-Downlight provides near-perfect light color, with a CRI of 98, by integrating powerful Xicato lighting technology.

**3" Shallow Plenum** – The Eco-Downlight Shallow Plenum housing's low 2½-inch profile allows for versatility and style in restricted ceiling installations.



# 3" Standard Housings

## 3" Standard New Construction (Non-IC)

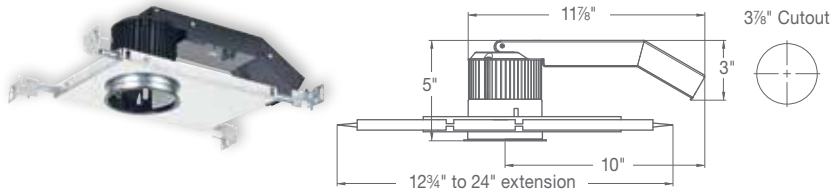

### 120-277V 24W Integral Driver

50/60 Hz, INC/ELV/0-10V Standard dimming to 10%

EDL-NC-27-4	LED, 2,700°K ±50°K, CRI 90, 1900 lm
EDL-NC-30-4	LED, 3,000°K ±50°K, CRI 90, 2035 lm
EDL-NC-35-4	LED, 3,500°K ±50°K, CRI 90, 2186 lm
EDL-NC-40-4	LED, 4,000°K ±50°K, CRI 80, 2691 lm

## 3" Standard Remodel/Retrofit

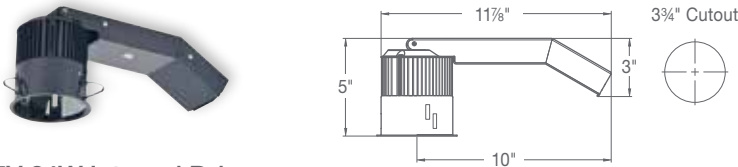

### 120-277V 24W Integral Driver

50/60 Hz, INC/ELV/0-10V Standard dimming to 10%

EDL-RM-27-4	LED, 2,700°K ±50°K, CRI 90, 1900 lm
EDL-RM-30-4	LED, 3,000°K ±50°K, CRI 90, 2035 lm
EDL-RM-35-4	LED, 3,500°K ±50°K, CRI 90, 2186 lm
EDL-RM-40-4	LED, 4,000°K ±50°K, CRI 80, 2691 lm

## 3" Standard IC/Airtight /Adjustable

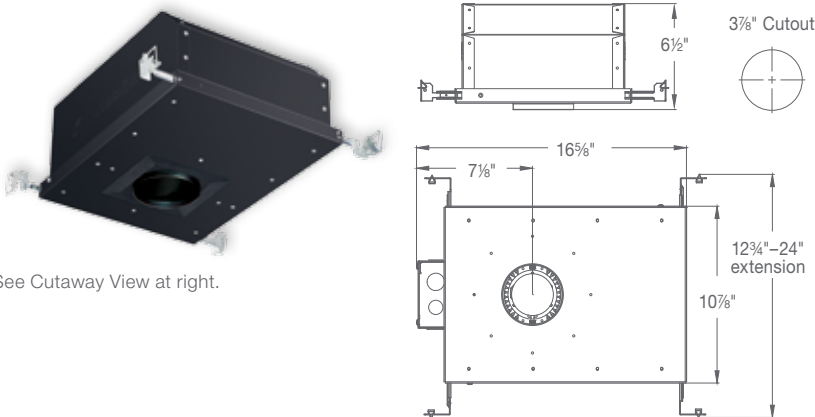

See Cutaway View at right.

### 120-277V 24W Integral Driver

50/60 Hz, INC/ELV/0-10V Standard dimming to 10%

EDL-ADJ-27-4	LED, 2,700°K ±50°K, CRI 90, 1900 lm
EDL-ADJ-30-4	LED, 3,000°K ±50°K, CRI 90, 2035 lm
EDL-ADJ-35-4	LED, 3,500°K ±50°K, CRI 90, 2186 lm
EDL-ADJ-40-4	LED, 4,000°K ±50°K, CRI 80, 2691 lm

**WARNING:** Polycell spray-in foam insulation requires setback of 3" from all sides and top of housing.

### Fixture

- Integral 120-277V input LED driver, 24W, 90% efficient, 0.99 power factor
- Field-replaceable light engine and driver
- UL/C-UL listed for damp location

### LEDs

- High-performance COB LEDs:
  - 24W, 2,700°K ±50, CRI 90, 1900 lm
  - 24W, 3,000°K ±50, CRI 90, 2035 lm
  - 24W, 3,500°K ±50, CRI 90, 2186 lm
  - 24W, 4,000°K ±50, CRI 80, 2691 lm
- 2-step binning process
- 50,000 hours at 70% lumen maintenance (L70)
- LM79 test results available at [cslighting.com](http://cslighting.com)

### Dimming

- Standard dimming compatible with INC (incandescent/triac), ELV or 0-10V dimmers to 10%
  - Lutron dimming options available\*:
    - L1 – Lutron A Series Hi-Lume 2-Wire
    - L2 – Lutron Eco System 5 Series
    - L3 – Lutron Hi-Lume H Series Fade-to-Black
    - L4 – Lutron A Series Hi-Lume 3-Wire
  - EldoLED dimming options available\*:
    - EL1 – EldoLED DALI
    - EL2 – EldoLED 0-10V
- \* See ordering example on page 15.

### Housing/Heat Sink

- 30°, 50° and 80° optics included; optional optic: Very Narrow 10°
- Extruded aluminum heat sink; black anodized finish

### New Construction and Remodel/Retrofit

- Cold-rolled steel housing with black powder-coat finish
- Mounting:
  - New Construction:** Galvanized-steel plaster frame, adjustable hanger bars
  - Remodel/Retrofit:** Black oxide-coated, heat-treated spring steel mounting clips (included)
- Adjusts vertically to accommodate ceiling thicknesses from 1/2" to 1"
- Aluminum junction box with two 1/2" trade-size knockouts

### IC/Airtight

- Aluminum airtight housing with black powder-coat finish
- Adjustable, rotating heat sink:
  - Vertical aiming up to 45° tilt
  - Horizontal aiming 359° rotation
- Galvanized steel adjustable hanger bars
- Accommodates ceiling thicknesses up to 1"
- Steel junction box with black anodized finish and four 1/2" and four 3/4" trade-size knockouts

# 3" LPD Housings (Low-Power Density)

## 3" LPD New Construction (IC/Airtight Rated\*)

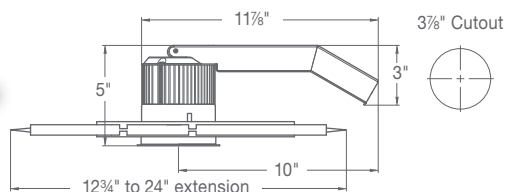

### 120V 15W Integral Driver

50/60 Hz, INC/ELV Standard dimming to 10%

**EDL-NC-27-4-LPD** LED, 2,700°K ±50°K, CRI 90, 1200 lm

**EDL-NC-30-4-LPD** LED, 3,000°K ±50°K, CRI 90, 1300 lm

## 3" LPD Remodel/Retrofit (IC/Airtight Rated\*)

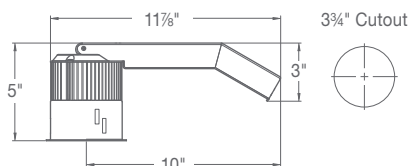

### 120V 15W Integral Driver

50/60 Hz, INC/ELV Standard dimming to 10%

**EDL-RM-27-4-LPD** LED, 2,700°K ±50°K, CRI 90, 1200 lm

**EDL-RM-30-4-LPD** LED, 3,000°K ±50°K, CRI 90, 1300 lm

## 3" LPD IC/Airtight /Adjustable

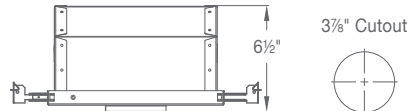
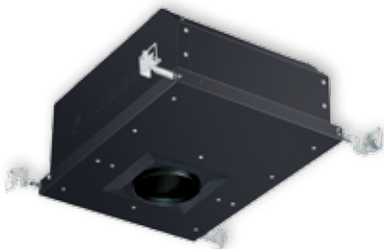

Cutaway view

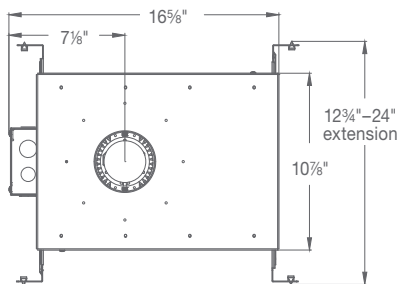

### 120V 15W Integral Driver

50/60 Hz, INC/ELV Standard dimming to 10%

**EDL-ADJ-27-4-LPD** LED, 2,700°K ±50°K, CRI 90, 1200 lm

**EDL-ADJ-30-4-LPD** LED, 3,000°K ±50°K, CRI 90, 1300 lm

\* IC/Airtight option for EDL-NC and EDL-RM requires gasket accessory (EDL-AT-GSKT).

**WARNING:** Polycell spray-in foam insulation requires setback of 3" from all sides and top of housing.

### Fixture

- Integral 120V input LED driver, 15W, 90% efficient, 0.99 power factor
- Field-replaceable light engine and driver
- UL/C-UL listed for damp location

### LEDs

- High-performance COB LEDs:
  - 15W, 2,700°K, ±50, CRI 90, 1200 lm
  - 15W, 3,000°K, ±50, CRI 90, 1300 lm
- 2-step binning process
- 50,000 hours at 70% lumen maintenance (L70)
- LM79 test results available at [cslighting.com](http://cslighting.com)
- Standard dimming compatible with INC (incandescent/triac) or ELV dimmers to 10%

### Housing/Heat Sink

#### New Construction and Remodel

- 50° optic included; optional optics: 10° Very Narrow, 30° Narrow, 80° Wide Flood
- Extruded aluminum heat sink with black anodized finish

#### New Construction and Remodel/Retrofit

- Cold-rolled steel housing with black powder-coat finish
- Mounting:
  - New Construction:** Galvanized-steel plaster frame, adjustable hanger bars
  - Remodel/Retrofit:** Black oxide-coated, heat-treated spring steel mounting clips (included)

- Adjusts vertically to accommodate ceiling thicknesses from 1/2" to 1"
- Aluminum junction box with two 1/2" trade-size knockouts

#### IC/Airtight

- Aluminum airtight housing with black powder-coat finish
- Adjustable, rotating heat sink:
  - Vertical aiming up to 45° tilt
  - Horizontal aiming 359° rotation
- Galvanized steel adjustable hanger bars
- Accommodates ceiling thicknesses up to 1"
- Cold-rolled steel junction box with black anodized finish and four 1/2" and four 3/4" trade-size knockouts

# 3" Specialty Trims & Accessories

## 3" Standard/LPD/Shallow Plenum

### EDL-5000 Series – Round Trimless Reflectors



<b>EDL-5000-4</b>	<b>EDL-5001-4</b>	<b>EDL-5002-4</b>	<b>EDL-5003-4</b>
White Reflector	Satin Aluminum Reflector	Bronze Reflector	Black Reflector

### EDL-5100 Series – Round Trimless Baffles



<b>EDL-5100-4</b>	<b>EDL-5101-4</b>	<b>EDL-5102-4</b>	<b>EDL-5103-4</b>
White Baffle	Satin Aluminum Baffle	Bronze Baffle	Black Baffle

### EDL-7000 Series – Round Trimless Adjustable Reflectors



<b>EDL-7000-4</b>	<b>EDL-7001-4</b>	<b>EDL-7002-4</b>	<b>EDL-7003-4</b>
White Reflector	Satin Aluminum Reflector	Bronze Reflector	Black Reflector

### EDL-7100 Series – Round Trimless Adjustable Baffles



<b>EDL-7100-4</b>	<b>EDL-7101-4</b>	<b>EDL-7102-4</b>	<b>EDL-7103-4</b>
White Baffle	Satin Aluminum Baffle	Bronze Baffle	Black Baffle

### EDL-1700 Series – Wallwash Trims – Standard & LPD only



<b>EDL-1700-4</b>	<b>EDL-1701-4</b>	<b>EDL-1702-4</b>
White	Satin Aluminum	Bronze

### EDL-1800 Series – Double Wallwash Trims – Standard & LPD only



<b>EDL-1800-4</b>	<b>EDL-1801-4</b>	<b>EDL-1802-4</b>
White	Satin Aluminum	Bronze

### EDL Trimless Rings



<b>EDL-RD-TR-4</b>
Round Trimless Ring (for use with ADJ housings only)

### EDL Accessories



<b>EDL-RD-FMA</b>	<b>EDL-SQ-FMA</b>	<b>EDL-10-OPTIC-4</b>	<b>EDL-30-OPTIC-4</b>	<b>EDL-50-OPTIC-4</b>	<b>EDL-80-OPTIC-4</b>	<b>EM-1000</b>	<b>EM-1002</b>
Round Flush Mount Adapter (FMA) Ring	Round Flush Mount Adapter (FMA) Ring	Very Narrow 10° Optic	Narrow 30° Optic*	Wide 50° Optic	Wide Flood 80° Optic	25W LED Remote Inverter	10W EM Battery (field installable)



<b>EDL-CL-4</b>	<b>EDL-FT-4</b>	<b>EDL-MP-4</b>	<b>EDL-LN-4</b>	<b>EDL-MHLDR-4</b>	<b>EDL-AT-GSKT</b>
Clear Lens	Frosted Lens	Prismatic Lens	Linear Lens	Media Holder	Gasket (for LPD RM & NC housings only)



# 3" Shallow Plenum Housing

## 3" Shallow Plenum IC/Airtight

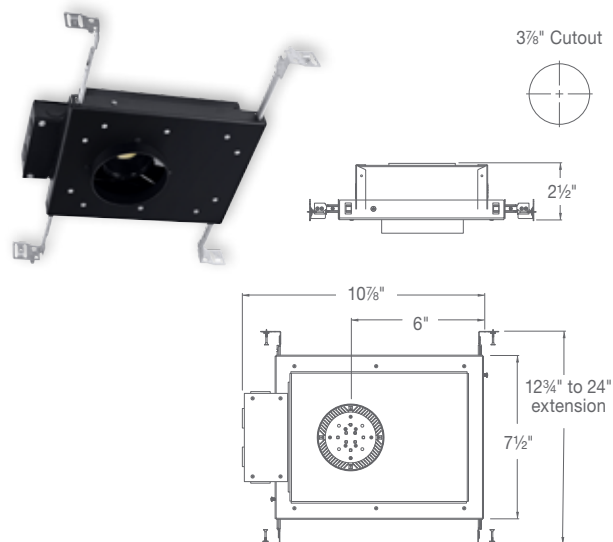

### 120-277V 15W Integral Driver

50/60 Hz, INC/ELV/0-10V Universal dimming

<b>EDL-SIC-27-4</b>	LED, 2,700°K ±50°K, CRI 90, 1425 lm
<b>EDL-SIC-30-4</b>	LED, 3,000°K ±50°K, CRI 90, 1525 lm
<b>EDL-SIC-35-4</b>	LED, 3,500°K ±50°K, CRI 90, 1631 lm
<b>EDL-SIC-40-4</b>	LED, 4,000°K ±50°K, CRI 80, 1745 lm

### Fixture

- Integral 120-277V input LED driver, 15W, 90% efficient, 0.99 power factor
- Field-replaceable light engine and driver
- UL/C-UL listed for damp location

### LEDs

- High-performance COB LEDs:
  - 15W, 2,700°K ±50, CRI 90, 1425lm
  - 15W, 3,000°K ±50, CRI 90, 1525 lm
  - 15W, 3,500°K ±50, CRI 90, 1631 lm
  - 15W, 4,000°K ±50, CRI 80, 1745 lm
- 2-step binning process
- 50,000 hours at 70% lumen maintenance (L70)
- LM79 test results available at [cslighting.com](http://cslighting.com)
- INC/ELV/0-10V Universal dimming

### Housing/Heat Sink

- 30°, 50° and 80° optics included
- Aluminum airtight housing with black powder-coat finish
- Machined aluminum heat sink with black anodized finish
- Accommodates ceiling thicknesses up to 1"
- Galvanized steel adjustable hanger bars
- Steel junction box with black anodized finish and four 1/2" trade-size knockouts

## Ordering Example: Dimming Options – 3" Standard Housings only

<b>EDL</b>	-	<b>ADJ</b>	-	<b>27</b>	-	<b>4</b>	-	_____
FIXTURE		HOUSING TYPE		LIGHT COLOR		VERSION NUMBER		DIMMING OPTIONS
		<b>NC</b> – New Construction		<b>27</b> – 2700°K				<b>BLANK</b> – Standard Dimming
		<b>RM</b> – Remodel/Retrofit		<b>30</b> – 3000°K				<b>L1</b> – Lutron A Series Hi-Lume 2-Wire
		<b>ADJ</b> – Adjustable		<b>35</b> – 3500°K				<b>L2</b> – Lutron Eco-System 5 Series
				<b>40</b> – 4000°K				<b>L3</b> – Lutron Hi-Lume H Series Fade-to-Black
								<b>L4</b> – Lutron A Series Hi-Lume 3-Wire
								<b>EL1</b> – EldoLED DALI
								<b>EL2</b> – EldoLED 0-10V

# 3" Trims

## 3" Round Standard/LPD/Shallow Plenum

### EDL-1000 Series



NUMBER	<b>EDL-1000-4</b> ■	<b>EDL-1001-4</b> ■	<b>EDL-1002-4</b> ■	<b>EDL-1003-4</b> ■	<b>EDL-1004-4</b> ■
TRIM FINISH	White	White	Satin Aluminum	Satin Aluminum	White
REFLECTOR/BAFFLE	Clear Alzak Reflector	Black Alzak Reflector	Clear Alzak Reflector	Black Alzak Reflector	Haze Reflector



NUMBER	<b>EDL-1005-4</b> ■	<b>EDL-1006-4</b> ■	<b>EDL-1007-4</b> ■
TRIM FINISH	Satin Aluminum	White	Bronze
REFLECTOR/BAFFLE	Haze Reflector	White Reflector	Bronze Reflector

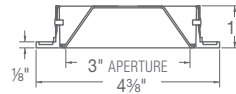

### EDL-1100 Series



NUMBER	<b>EDL-1100-4</b> ■	<b>EDL-1101-4</b> ■	<b>EDL-1102-4</b> ■	<b>EDL-1103-4</b> ■
TRIM FINISH	White	White	Satin Aluminum	Bronze
REFLECTOR/BAFFLE	White Baffle	Black Baffle	Black Baffle	Bronze Baffle

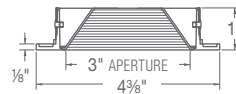

### EDL-1200 Series



NUMBER	<b>EDL-1200-4</b>	<b>EDL-1201-4</b>
TRIM FINISH	White	Satin Aluminum
REFLECTOR/BAFFLE	Shower Light	Shower Light

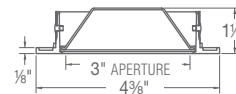

#### Materials

- Trim Rings: Diecast aluminum
- Reflectors and Baffles: Round – Spun aluminum and diecast aluminum  
Square – Diecast aluminum

#### Finishes

- Standard Finishes: White Powder Coat, Satin Aluminum, Bronze
- RAL color matching available (consult factory)

#### Standard Accessories

- Optional optic: Very Narrow 10° (add -10 to trim part number when ordering 10° Optic – round trims only)
- Round and square Flush Mount Adapter (FMA) rings
- 25W LED Inverter
- 10W EM Battery (field installable)

#### LPD Accessories

- Optional optics: Very Narrow 10°, Narrow 30°, Wide Flood 80° (add -10 to trim part number when ordering 10° Optic – round trims only)
- Round and square Flush Mount Adapter (FMA) rings
- Gasket
- 25W LED Inverter
- 10W EM Battery (field installable)



■ Indicates Title 24-compliant trim. Title 24-compliance applies to trims when used on Standard fixtures, not LPD.

## 3" Square Standard/LPD/Shallow Plenum

### EDL-2000 Series

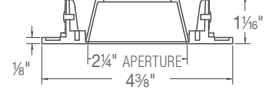

NUMBER	<b>EDL-2000-4</b>	<b>EDL-2001-4</b>	<b>EDL-2002-4</b>	<b>EDL-2003-4</b>	<b>EDL-2004-4</b>	<b>EDL-2005-4</b>
TRIM FINISH	White	White	White	Satin Aluminum	Satin Aluminum	Bronze
REFLECTOR/ BAFFLE	White Reflector	Black Reflector	Haze Reflector	Black Reflector	Haze Reflector	Bronze Reflector

### EDL-2100 Series

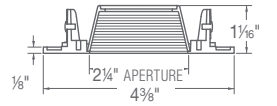

NUMBER	<b>EDL-2100-4</b>	<b>EDL-2101-4</b>	<b>EDL-2102-4</b>	<b>EDL-2103-4</b>
TRIM FINISH	White	White	Satin Aluminum	Bronze
REFLECTOR/ BAFFLE	White Baffle	Black Baffle	Black Baffle	Bronze Baffle

### EDL-2200 Series

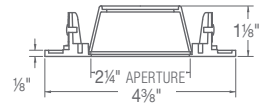

NUMBER	<b>EDL-2200-4</b>	<b>EDL-2201-4</b>
TRIM FINISH	White	Satin Aluminum
REFLECTOR/ BAFFLE	Shower Light	Shower Light

# 3" Adjustable Trims

## 3" Round Standard IC/LPD IC

### EDL-1300 Series

NUMBER	<b>EDL-1300-4</b> ■	<b>EDL-1301-4</b> ■	<b>EDL-1302-4</b> ■	<b>EDL-1303-4</b> ■	<b>EDL-1304-4</b> ■
ADJUSTMENT	0°–45°	0°–45°	0°–45°	0°–45°	0°–45°
TRIM FINISH	White	White	Satin Aluminum	Satin Aluminum	White
REFLECTOR/ BAFFLE	Clear Alzak Reflector	Black Alzak Reflector	Clear Alzak Reflector	Black Alzak Reflector	Haze Reflector

NUMBER	<b>EDL-1305-4</b> ■	<b>EDL-1306-4</b> ■	<b>EDL-1307-4</b> ■
ADJUSTMENT	0°–45°	0°–45°	0°–45°
TRIM FINISH	Satin Aluminum	White	Bronze
REFLECTOR/ BAFFLE	Haze Reflector	White Reflector	Bronze Reflector

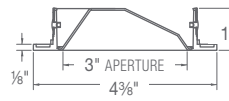

#### Materials

- Trim Rings: Diecast aluminum
- Reflectors and Baffles: Round – Spun aluminum and diecast aluminum  
Square – Diecast aluminum

#### Finishes

- Standard Finishes: White Powder Coat, Satin Aluminum, Bronze
- RAL color matching available (consult factory)



■ Indicates Title 24-compliant trim. Title 24-compliance applies to trims when used on Standard fixtures, not LPD.

### EDL-1400 Series

NUMBER	<b>EDL-1400-4</b> ■	<b>EDL-1401-4</b> ■	<b>EDL-1402-4</b> ■	<b>EDL-1403-4</b> ■
ADJUSTMENT	0°–45°	0°–45°	0°–45°	0°–45°
TRIM FINISH	White	White	Satin Aluminum	Bronze
REFLECTOR/ BAFFLE	White Baffle	Black Baffle	Black Baffle	Bronze Baffle

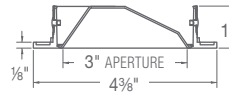

### EDL-3000 Series

NUMBER	<b>EDL-3000-4</b>	<b>EDL-3001-4</b>	<b>EDL-3002-4</b>
ADJUSTMENT	Adjust All	Adjust All	Adjust All
TRIM FINISH	White	Satin Aluminum	Bronze
REFLECTOR/ BAFFLE	Solite Glass	Solite Glass	Solite Glass

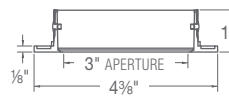

## 3" Square Standard IC/LPD IC

### EDL-1500 Series

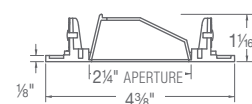

NUMBER	<b>EDL-1500-4</b>	<b>EDL-1501-4</b>	<b>EDL-1502-4</b>
ADJUSTMENT	0°–45°	0°–45°	0°–45°
TRIM FINISH	White	White	White
REFLECTOR/ BAFFLE	White Reflector	Black Alzak Reflector	Haze Reflector



NUMBER	<b>EDL-1503-4</b>	<b>EDL-1504-4</b>	<b>EDL-1505-4</b>
ADJUSTMENT	0°–45°	0°–45°	0°–45°
TRIM FINISH	Satin Aluminum	Satin Aluminum	Bronze
REFLECTOR/ BAFFLE	Black Alzak Reflector	Haze Reflector	Bronze Reflector

### EDL-1600 Series

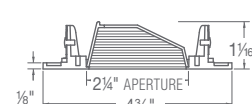

NUMBER	<b>EDL-1600-4</b>	<b>EDL-1601-4</b>	<b>EDL-1602-4</b>	<b>EDL-1603-4</b>
ADJUSTMENT	0°–45°	0°–45°	0°–45°	0°–45°
TRIM FINISH	White	White	Satin Aluminum	Bronze
REFLECTOR/ BAFFLE	White Baffle	Black Baffle	Black Baffle	Bronze Baffle

### EDL-4000 Series

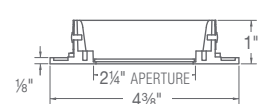

NUMBER	<b>EDL-4000-4</b>	<b>EDL-4001-4</b>	<b>EDL-4002-4</b>
ADJUSTMENT	Adjust All	Adjust All	Adjust All
TRIM FINISH	White	Satin Aluminum	Bronze
REFLECTOR/ BAFFLE	Solite Glass	Solite Glass	Solite Glass

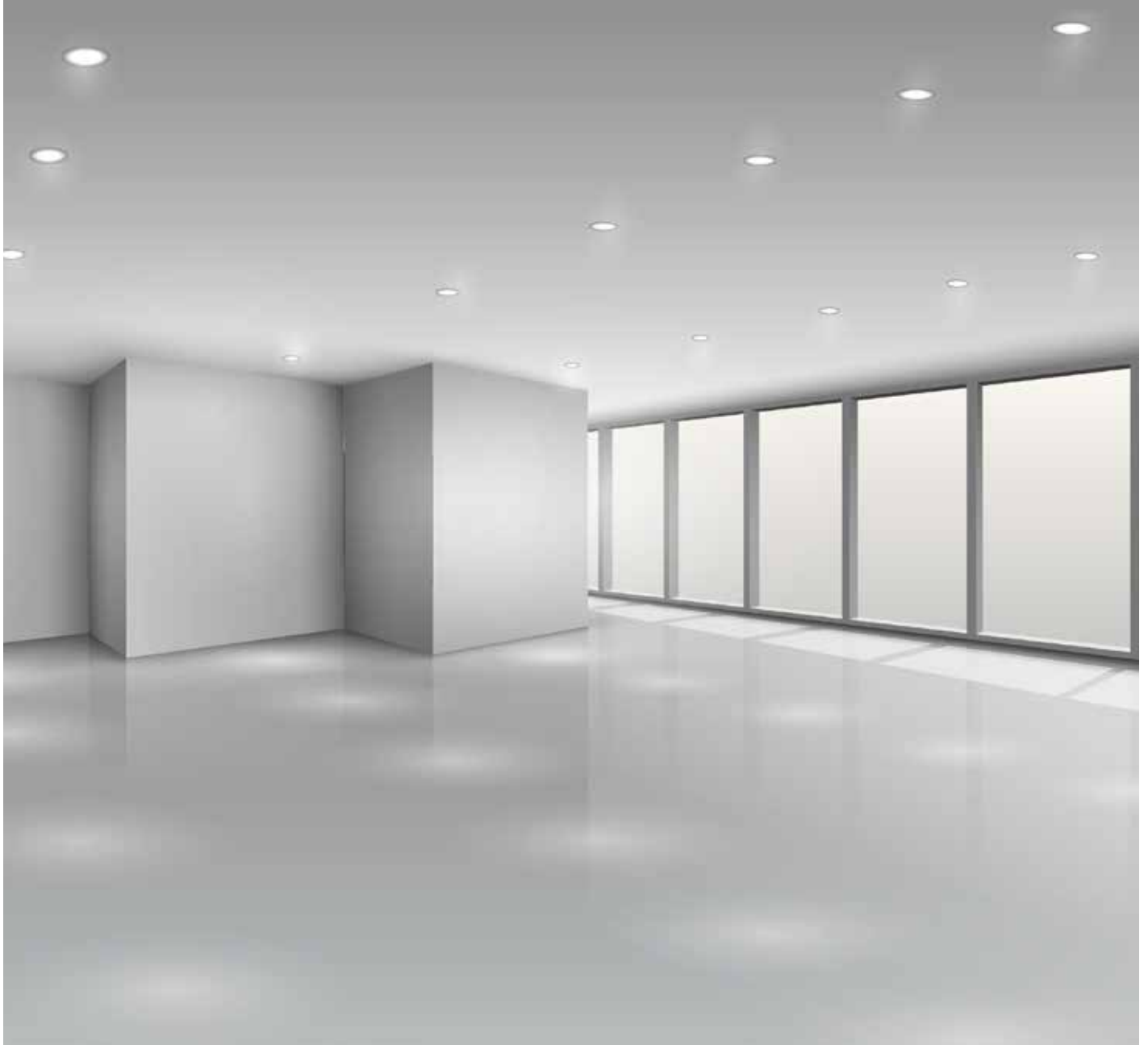

# 3" Xicato<sup>®</sup> Eco-Downlight



Integrating innovative lighting technology from Xicato®, a leading LED module developer known for superior light quality, with the performance and precision of CSL downlight fixtures, we introduce the CSL 3" Xicato Eco-Downlight, designed to enhance the quality of light and aesthetics for a multitude of environments.



# 3" Xicato® Housings

## 3" Xicato New Construction (Non-IC)

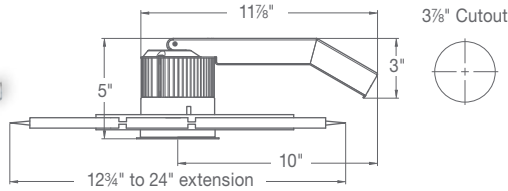

### 120-277V 22W Integral Driver

50/60 Hz, INC/ELV/0-10V Standard dimming to 10%

**EDL-NC-30-4X** LED, 3,000°K ±50°K, CRI 98, 1650 lm

**EDL-NC-35-4X** LED, 3,500°K ±50°K, CRI 98, 1650 lm

## 3" Xicato Remodel/Retrofit

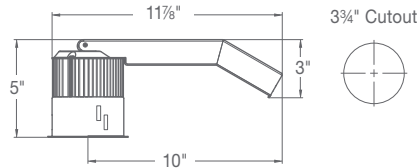

### 120-277V 22W Integral Driver

50/60 Hz, INC/ELV/0-10V Standard dimming to 10%

**EDL-RM-30-4X** LED, 3,000°K ±50°K, CRI 98, 1650 lm

**EDL-RM-35-4X** LED, 3,500°K ±50°K, CRI 98, 1650 lm

## 3" Xicato IC/Airtight /Adjustable

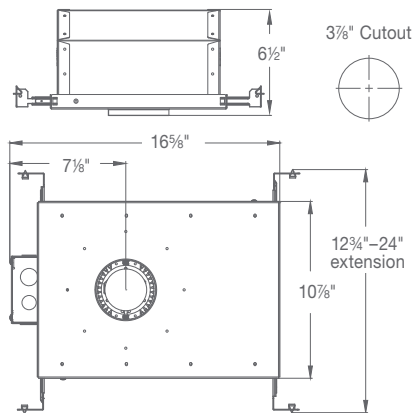
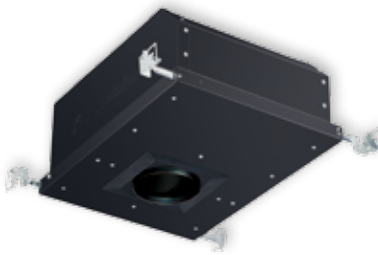

### 120-277V 22W Integral Driver

50/60 Hz, INC/ELV/0-10V Standard dimming to 10%

**EDL-ADJ-30-4X** LED, 3,000°K ±50°K, CRI 98, 1650 lm

**EDL-ADJ-35-4X** LED, 3,500°K ±50°K, CRI 98, 1650 lm

## Ordering Example: Dimming Options – 3" Xicato Housings only

EDL	ADJ	30	4X	
FIXTURE	HOUSING TYPE	LIGHT COLOR	VERSION #	DIMMING OPTIONS
NC – New Construction	RM – Remodel/Retrofit	ADJ – Adjustable	30 – 3000°K	35 – 3500°K
<b>BLANK</b> – Std. Dimming <b>L1</b> – Lutron A Series Hi-Lume 2-Wire <b>L2</b> – Lutron Eco-System 5 Series <b>L3</b> – Lutron Hi-Lume H Series Fade-to-Black <b>L4</b> – Lutron A Series Hi-Lume 3-Wire <b>EL1</b> – EldoLED DALI <b>EL2</b> – EldoLED 0-10V				

### Fixture

- Integral 120-277V input LED driver, 22W, 90% efficient, 0.99 power factor
- Field-replaceable light engine and driver
- UL/C-UL listed for damp location

### LEDs

- High-performance COB LEDs:
  - 22W, 3,000°K ±50, CRI 98, 1650 lm
  - 22W, 3,500°K ±50, CRI 98, 1650 lm
- 2-step binning process
- 50,000 hours at 70% lumen maintenance (L70)
- LM79 test results available at [csllighting.com](http://csllighting.com)

### Dimming (See ordering example below.)

- Standard dimming compatible with INC (incandescent/triac), ELV or 0-10V dimmers to 10%
- Lutron dimming options available\*:
  - **L1** – Lutron A Series Hi-Lume 2-Wire
  - **L2** – Lutron Eco System 5 Series
  - **L3** – Lutron Hi-Lume H Series Fade-to-Black
  - **L4** – Lutron A Series Hi-Lume 3-Wire
- EldoLED dimming options available\*:
  - **EL1** – EldoLED DALI
  - **EL2** – EldoLED 0-10V

### Housing/Heat Sink

- Reflectors ordered separately:
  - RFLR-1000** – Spot Reflector
  - RFLR-1001** – Flood Reflector
  - RFLR-1002** – Wide Flood Reflector
- Extruded aluminum heat sink, black anodized finish

### New Construction and Remodel/Retrofit

- Cold-rolled steel housing, black powder-coat finish
- Mounting:
  - New Construction:** Galvanized-steel plaster frame, adjustable hanger bars
  - Remodel/Retrofit:** Black oxide-coated, heat-treated spring steel mounting clips (included)
- Adjusts vertically to accommodate ceiling thicknesses from 1/2" to 1"
- Aluminum junction box with two 1/2" trade-size knockouts

### IC/Airtight

- Aluminum airtight housing, black powder-coat finish
- Adjustable, rotating heat sink:
  - Vertical aiming up to 45° tilt
  - Horizontal aiming 359° rotation
- Galvanized steel adjustable hanger bars
- Adjusts vertically to accommodate ceiling thicknesses up to 1"
- Steel junction box with black anodized finish and four 1/2" and four 3/4" trade-size knockouts

**WARNING:** Polycell spray-in foam insulation requires setback of 3" from all sides and top of housing.



# 3" Xicato® Trims & Accessories

## 3" Round

### EDL-1000 Series



NUMBER	EDL-1001-4X	EDL-1003-4X	EDL-1004-4X	EDL-1005-4X	EDL-1006-4X	EDL-1007-4X
TRIM FINISH	White	Satin Aluminum	White	Satin Aluminum	White	Bronze
REFLECTOR/ BAFFLE	Black Alzak Reflector	Black Alzak Reflector	Haze Reflector	Haze Reflector	White Reflector	Bronze Reflector

### EDL-1100 Series

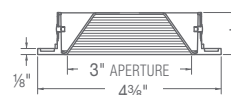

NUMBER	EDL-1100-4X	EDL-1101-4X	EDL-1102-4X	EDL-1103-4X
TRIM FINISH	White	White	Satin Aluminum	Bronze
REFLECTOR/ BAFFLE	White Baffle	Black Baffle	Black Baffle	Bronze Baffle

#### Materials

- Trim Rings: Diecast aluminum
- Reflectors and Baffles: Spun aluminum and diecast aluminum

#### Finishes

- Standard Finishes: White Powder Coat, Satin Aluminum, Bronze
- RAL color matching available (consult factory)

#### Xicato Accessories

- Round Flush Mount Adapter (FMA) ring
- 25W LED Inverter
- 10W EM Battery (field installable)

### EDL-1200 Series

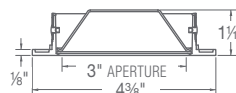

NUMBER	EDL-1200-4X	EDL-1201-4X
TRIM FINISH	White	Satin Aluminum
LENS	Shower Light	Shower Light

# 3" Xicato® Adjustable Trims

### EDL-3000 Series

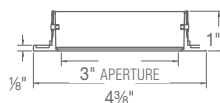

NUMBER	EDL-3000-4X	EDL-3001-4X
ADJUST	Adjust All	Adjust All
TRIM FINISH	White	Satin Aluminum
LENS	Solite Glass	Solite Glass

# 3" Xicato® Accessories

### EDL Accessories Reflectors



(not included in housing; order separately)

EDL-RD-FMA	EM-1000	RFLR-1000	RFLR-1001	RFLR-1002
Round Flush Mount Adapter (FMA) Ring	25W LED Remote Inverter	Spot Reflector	Flood Reflector	Wide Flood Reflector

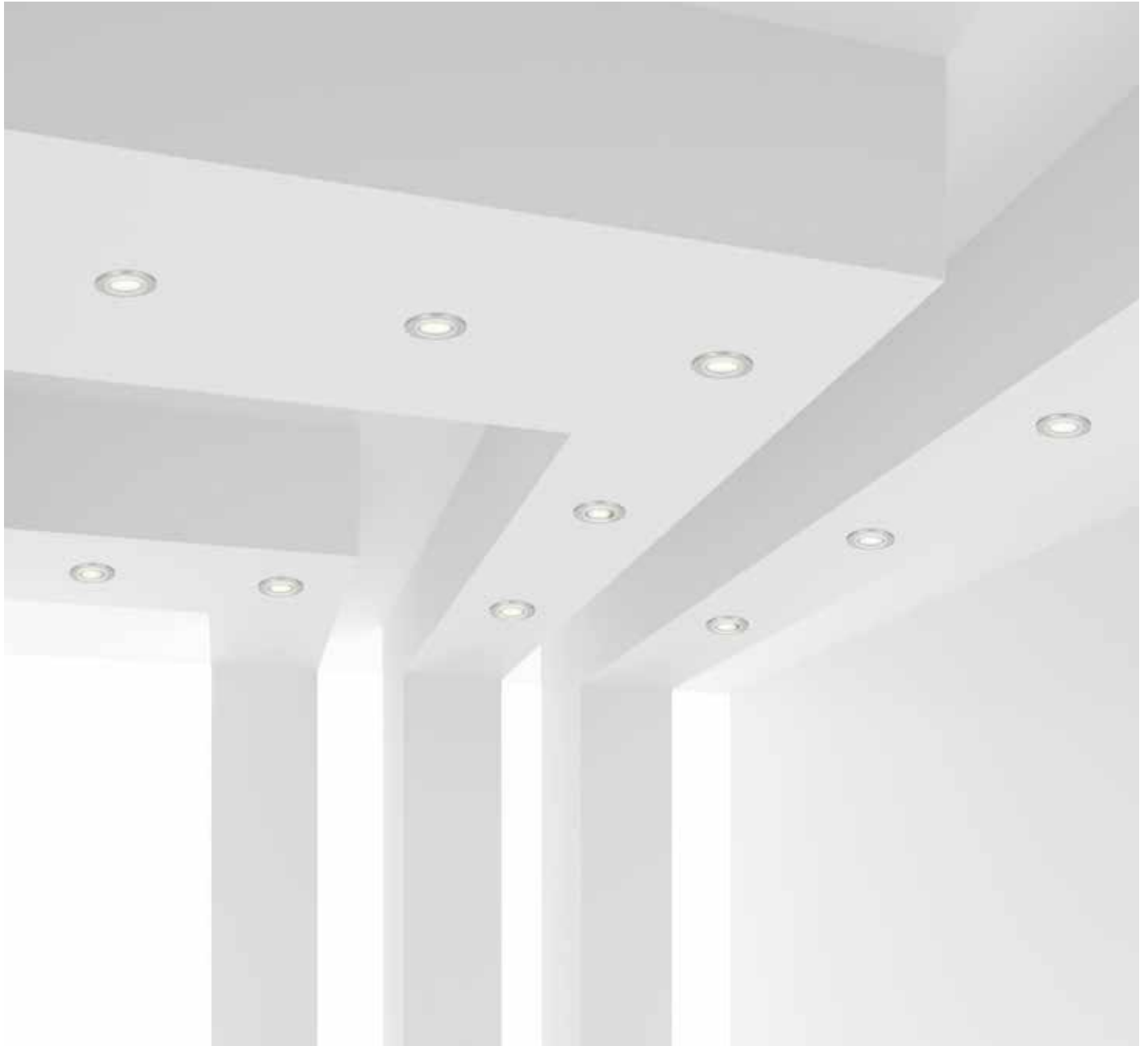

# 1" Mini Eco-Downlight



CSL's standard 1" Mini Eco-Downlight offers performance, functionality and energy efficiency in a compact fixture with a range features and options such as four color temperatures, multiple included optics, and expanded dimming choices, and is further enhanced with smart, scaled-down trims in three finishes, several of which are Title 24 tested and compliant.

To expand our variety of downlight products, CSL introduces the new 1" Mini Low Power Density (LPD) fixture. The Mini Eco-Downlight LPD provides superior lighting, with a power output considerably less than our standard 1" downlights.



# 1" Mini Standard Housings

## 1" Mini Standard New Construction (Non-IC)

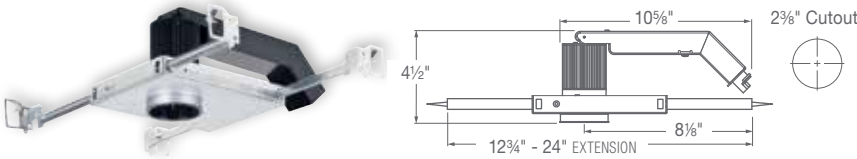

### 120-277V 14W Integral Driver

50/60 Hz, INC/ELV/0-10V Standard dimming to 10%

<b>EDLM-NC-27-3</b>	LED, 2,700°K ±50°K, CRI 90, 980 lm
<b>EDLM-NC-30-3</b>	LED, 3,000°K ±50°K, CRI 90, 1074 lm
<b>EDLM-NC-35-3</b>	LED, 3,500°K ±50°K, CRI 90, 1157 lm
<b>EDLM-NC-40-3</b>	LED, 4,000°K ±50°K, CRI 80, 1250 lm

## 1" Mini Standard Remodel/Retrofit

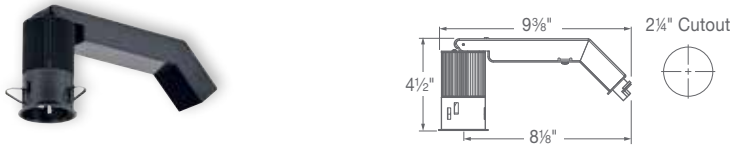

### 120-277V 14W Integral Driver

50/60 Hz, INC/ELV/0-10V Standard dimming to 10%

<b>EDLM-RM-27-3</b>	LED, 2,700°K ±50°K, CRI 90, 980 lm
<b>EDLM-RM-30-3</b>	LED, 3,000°K ±50°K, CRI 90, 1074 lm
<b>EDLM-RM-35-3</b>	LED, 3,500°K ±50°K, CRI 90, 1157 lm
<b>EDLM-RM-40-3</b>	LED, 4,000°K ±50°K, CRI 80, 1250 lm

## 1" Mini Standard IC/Airtight /Adjustable

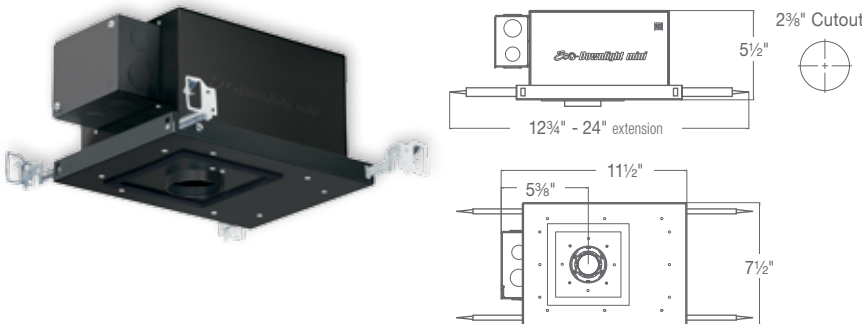

### 120-277V 14W Integral Driver

50/60 Hz, INC/ELV/0-10V Standard dimming to 10%

<b>EDLM-ADJ-27-3</b>	LED, 2,700°K ±50°K, CRI 90, 980 lm
<b>EDLM-ADJ-30-3</b>	LED, 3,000°K ±50°K, CRI 90, 1074 lm
<b>EDLM-ADJ-35-3</b>	LED, 3,500°K ±50°K, CRI 90, 1157 lm
<b>EDLM-ADJ-40-3</b>	LED, 4,000°K ±50°K, CRI 80, 1250 lm

**WARNING:** Polycell spray-in foam insulation requires setback of 3" from all sides and top of housing.

### Fixture

- Integral 120-277V input LED driver, 14W, 90% efficient, 0.99 power factor
- Field-replaceable light engine and driver
- UL/C-UL listed for damp location

### LEDs

- High-performance COB LEDs:
  - 14W, 2,700°K ±50, CRI 90, 980 lm
  - 14W, 3,000°K ±50, CRI 90, 1074 lm
  - 14W, 3,500°K ±50, CRI 90, 1157 lm
  - 14W, 4,000°K ±50, CRI 80, 1250 lm
- 2-step binning process
- 50,000 hours at 70% lumen maintenance (L70)
- LM79 test results available at [cslighting.com](http://cslighting.com)

### Dimming

- Standard dimming compatible with INC (incandescent/triac), ELV or 0-10V dimmers to 10%
  - Lutron dimming option available\*:
    - **LR1** – Lutron A Series Hi-Lume 2-Wire Remote
- \* See ordering example on page 29.

### Housing/Heat Sink

- 10°, 30°, 50° and 80° optics included
- Extruded aluminum heat sink with black anodized finish

### New Construction and Remodel/Retrofit

- Cold-rolled steel housing with black powder-coat finish
- Mounting:
  - New Construction:** Galvanized-steel plaster frame, adjustable hanger bars
  - Remodel/Retrofit:** Black oxide-coated, heat-treated spring steel mounting clips (included)
- Adjusts vertically to accommodate ceiling thicknesses from 1/2" to 3/4"
- Aluminum junction box with one 1/2" trade-size knockouts

### IC/Airtight

- Aluminum airtight housing with black powder-coat finish
- Adjustable, rotating heat sink:
  - Vertical aiming up to 15° tilt
  - Horizontal aiming 359° rotation
- Galvanized steel adjustable hanger bars
- Accommodates ceiling thicknesses up to 3/4"
- Steel junction box with black anodized finish and four 1/2" and four 3/4" trade-size knockouts

# 1" Mini LPD Housings (Low-Power Density)

## 1" Mini LPD New Construction (IC/Airtight Rated\*)

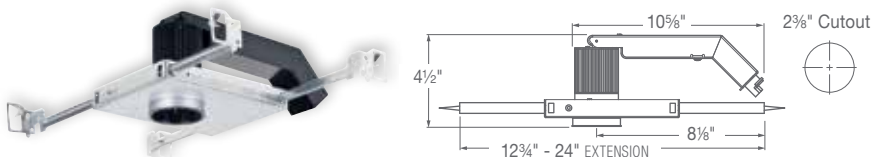

### 120V 10W Integral Driver

50/60 Hz, INC/ELV Standard dimming to 10%

**EDLM-NC-27-3-LPD** LED, 2,700°K ±50°K, CRI 90, 700 lm

**EDLM-NC-30-3-LPD** LED, 3,000°K ±50°K, CRI 90, 740 lm

## 1" Mini LPD Remodel/Retrofit (IC/Airtight Rated\*)

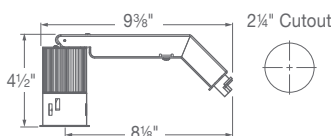

### 120V 10W Integral Driver

50/60 Hz, INC/ELV Standard dimming to 10%

**EDLM-RM-27-3-LPD** LED, 2,700°K ±50°K, CRI 90, 700 lm

**EDLM-RM-30-3-LPD** LED, 3,000°K ±50°K, CRI 90, 740 lm

## 1" Mini LPD IC/Airtight / Adjustable

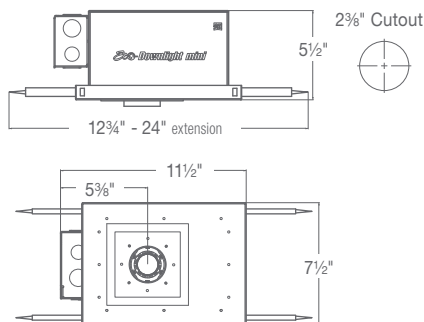
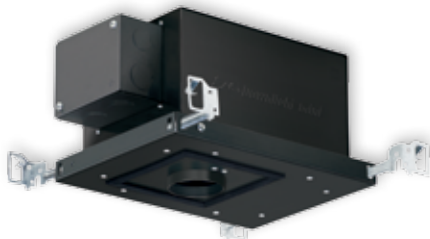

### 120V 10W Integral Driver

50/60 Hz, INC/ELV Standard dimming to 10%

**EDLM-ADJ-27-3-LPD** LED, 2,700°K ±50°K, CRI 90, 700 lm

**EDLM-ADJ-30-3-LPD** LED, 3,000°K ±50°K, CRI 90, 740 lm

### Fixture

- Integral 120V input LED driver, 10W, 90% efficient, 0.99 power factor
- Field-replaceable light engine and driver
- UL/C-UL listed for damp location

### LEDs

- High-performance COB LEDs:
  - 10W, 2,700°K, ±50, CRI 90, 700 lm
  - 10W, 3,000°K, ±50, CRI 90, 740 lm
- 2-step binning process
- 50,000 hours at 70% lumen maintenance (L70)
- LM79 test results available at [csllighting.com](http://csllighting.com)
- Standard dimming compatible with INC (incandescent/triac) or ELV dimmers to 10%

### Housing/Heat Sink

- 50° optic included; optional optics:
  - 10° Very Narrow, 30° Narrow, 80° Wide Flood
- Extruded aluminum heat sink with black anodized finish

### New Construction and Remodel/Retrofit

- Cold-rolled steel housing with black powder-coat finish
- Mounting:
  - New Construction:** Galvanized-steel plaster frame, adjustable hanger bars
  - Remodel/Retrofit:** Black oxide-coated, heat-treated spring steel mounting clips (included)

- Adjusts vertically to accommodate ceiling thicknesses from 1/2" to 3/4"
- Aluminum junction box with one 1/2" trade-size knockouts

### IC/Airtight

- Aluminum airtight housing with black powder-coat finish
- Adjustable, rotating heat sink:
  - Vertical aiming up to 15° tilt
  - Horizontal aiming 359° rotation
- Galvanized steel adjustable hanger bars
- Accommodates ceiling thicknesses up to 3/4"
- Cold-rolled steel junction box with black anodized finish and four 1/2" and four 3/4" trade-size knockouts

\* IC/Airtight option for EDLM-NC and EDLM-RM requires gasket accessory (EDLM-AT-GSKT).

**WARNING:** Polycell spray-in foam insulation requires setback of 3" from all sides and top of housing.

# 1" Mini Trims

## 1" Mini Round Standard/LPD

### EDLM-1000 Series



NUMBER	<b>EDLM-1001-3</b> ■	<b>EDLM-1003-3</b> ■	<b>EDLM-1004-3</b> ■
TRIM FINISH	White	Satin Aluminum	White
REFLECTOR/ BAFFLE	Black Alzak Reflector	Black Alzak Reflector	Haze Reflector



NUMBER	<b>EDLM-1005-3</b> ■	<b>EDLM-1006-3</b> ■
TRIM FINISH	Satin Aluminum	White
REFLECTOR/ BAFFLE	Haze Reflector	White Reflector

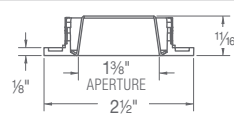

#### Materials

- Trim Rings: Diecast aluminum
- Reflectors and Baffles:  
Round – Spun aluminum and diecast aluminum  
Square – Diecast aluminum

#### Finishes

- Standard Finishes:  
White Powder Coat,  
Satin Aluminum
- RAL color matching  
available (consult factory)

#### Standard Accessories

- Round and square Flush Mount Adapter (FMA) rings
- Emergency Remote Battery Pack

#### LPD Accessories

- Optional optics:  
Very Narrow 10°, Narrow 30°, Wide Flood 80°
- Round and square Flush Mount Adapter (FMA) rings
- Gasket
- 25W LED Inverter
- 10W EM Battery (field installable)

### EDLM-1100 Series



NUMBER	<b>EDLM-1100-3</b> ■	<b>EDLM-1101-3</b> ■	<b>EDLM-1102-3</b> ■
TRIM FINISH	White	White	Satin Aluminum
REFLECTOR/ BAFFLE	White Baffle	Black Baffle	Black Baffle

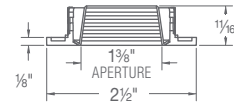

### EDLM-1200 Series



NUMBER	<b>EDLM-1200-3</b>
TRIM FINISH	White
REFLECTOR/ BAFFLE	Shower Light

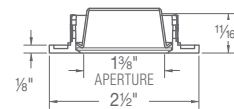

■ Indicates Title 24-compliant trim. Title 24-compliance applies to trims when used on Standard fixtures, not LPD.

# 1" Mini Square Standard/LPD

## EDLM-2000 Series

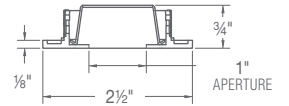

NUMBER	<b>EDLM-2001-3</b>	<b>EDLM-2003-3</b>	<b>EDLM-2004-3</b>	<b>EDLM-2005-3</b>
TRIM FINISH	White	Satin Aluminum	White	Satin Aluminum
REFLECTOR/ BAFFLE	Black Reflector	Black Reflector	Haze Reflector	Haze Reflector

## EDLM-2100 Series

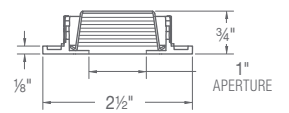
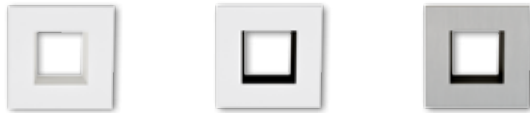

NUMBER	<b>EDLM-2100-3</b>	<b>EDLM-2101-3</b>	<b>EDLM-2102-3</b>
TRIM FINISH	White	White	Satin Aluminum
REFLECTOR/ BAFFLE	White Baffle	Black Baffle	Black Baffle

## EDLM-2200 Series

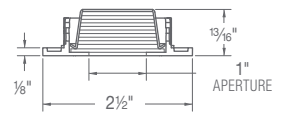

NUMBER	<b>EDLM-2200-3</b>
TRIM FINISH	White
REFLECTOR/ BAFFLE	Shower Light

## Ordering Example: Dimming Options – 1" Mini Standard Housing only

EDLM	-	ADJ	-	27	-	3	-	
FIXTURE		HOUSING TYPE		LIGHT COLOR		VERSION NUMBER		DIMMING OPTIONS
		<b>NC</b> – New Construction <b>RM</b> – Remodel/Retrofit <b>ADJ</b> – Adjustable		<b>27</b> – 2700°K <b>30</b> – 3000°K <b>35</b> – 3500°K <b>40</b> – 4000°K				<b>BLANK</b> – Standard Dimming <b>LR1</b> – Lutron A Series Hi-Lume 2-Wire Remote* <small>* Drivers are remote-mount only.</small>

# 1" Mini Adjustable Trims

## 1" Mini Round Standard IC/LPD IC

### EDLM-1300 Series



NUMBER	<b>EDLM-1301-3</b> ■	<b>EDLM-1303-3</b> ■	<b>EDLM-1304-3</b> ■
ADJUSTMENT	0°–15°	0°–15°	0°–15°
TRIM FINISH	White	Satin Aluminum	White
REFLECTOR/ BAFFLE	Black Alzak Reflector	Black Alzak Reflector	Haze Reflector



NUMBER	<b>EDLM-1305-3</b> ■	<b>EDLM-1306-3</b> ■
ADJUSTMENT	0°–15°	0°–15°
TRIM FINISH	Satin Aluminum	White
REFLECTOR/ BAFFLE	Haze Reflector	White Reflector

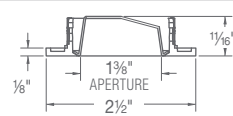

#### Materials

- Trim Rings: Diecast aluminum
- Reflectors and Baffles:  
Round – Spun aluminum and diecast aluminum  
Square – Diecast aluminum

#### Finishes

- Standard Finishes:  
White Powder Coat,  
Satin Aluminum
- RAL color matching available (consult factory)

#### Standard Accessories

- Round and square Flush Mount Adapter (FMA) rings
- Emergency Remote Battery Pack

#### LPD Accessories

- Optional optics:  
Very Narrow 10°, Narrow 30°, Wide Flood 80°
- Round and square Flush Mount Adapter (FMA) rings
- Gasket
- 25W LED Inverter
- 10W EM Battery (field installable)

### EDLM-1400 Series



NUMBER	<b>EDLM-1400-3</b> ■	<b>EDLM-1401-3</b> ■	<b>EDLM-1402-3</b> ■
ADJUSTMENT	0°–15°	0°–15°	0°–15°
TRIM FINISH	White	White	Satin Aluminum
REFLECTOR/ BAFFLE	White Baffle	Black Baffle	Black Baffle

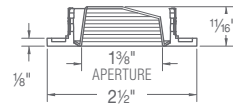

■ Indicates Title 24-compliant trim. Title 24-compliance applies to trims when used on Standard fixtures, not LPD.



## 1" Mini Square Standard IC/LPD IC

### EDLM-1500 Series

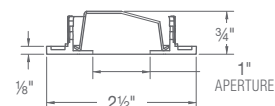

NUMBER	EDLM-1501-3	EDLM-1503-3	EDLM-1504-3	EDLM-1505-3	EDLM-1506-3
ADJUSTMENT	0°-15°	0°-15°	0°-15°	0°-15°	0°-15°
TRIM FINISH	White	Satin Aluminum	White	Satin Aluminum	White
REFLECTOR/ BAFFLE	Black Alzak Reflector	Black Alzak Reflector	Haze Reflector	Haze Reflector	White Reflector

### EDLM-1600 Series

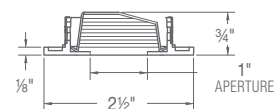

NUMBER	EDLM-1600-3	EDLM-1601-3	EDLM-1602-3
ADJUSTMENT	0°-15°	0°-15°	0°-15°
TRIM FINISH	White	White	Satin Aluminum
REFLECTOR/ BAFFLE	White Baffle	Black Baffle	Black Baffle

## 1" EDLM Accessories



EDLM-RD-FMA	EDLM-SQ-FMA
Round Flush Mount Adapter (FMA) Ring	Round Flush Mount Adapter (FMA) Ring

EDLM-10-OPTIC-3	EDLM-30-OPTIC-3	EDLM-50-OPTIC-3	EDLM-80-OPTIC-3	EM-1000	EM-1002	EDLM-AT-GSKT
Very Narrow 10° Optic	Narrow 30° Optic	Wide 50° Optic	Wide Flood 80° Optic	25W LED Remote Inverter	10W EM Battery (field installable)	Gasket (for LPD RM & NC housings only)

# CRI

Color Rendering Index (CRI) measures the ability of a light source (such as LEDs) to show object colors compared to a familiar reference (such as natural light). A CRI of 100 represents the maximum value, or best representation of color rendering.

CSL Eco-Downlight LED light sources are CRI rated as high as 90.

There are fourteen (14) test colors used for LM-79 testing of LED sources.

## Test Colors Used in Calculating CRI

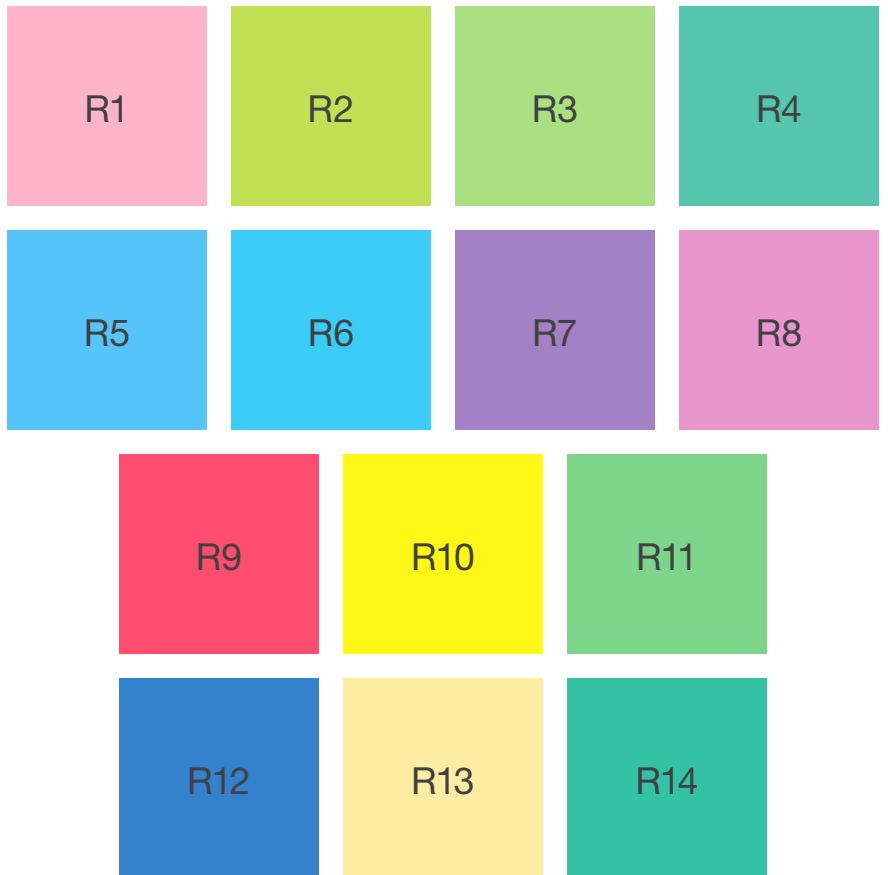

# Index

## Housings

EDL5-IC-27-1	4	EDL-NC-35-4X	22
EDL5-IC-27-LPD	5	EDL-NC-40-4	12
EDL5-IC-30-1	4	EDL-RM-27-4-LPD	13
EDL5-IC-30-LPD	5	EDL-RM-30-4	12
EDL5-IC-35-1	4	EDL-RM-30-4X	22
EDL5-IC-40-1	4	EDL-RM-30-4-LPD	13
EDL5-NC-27-1	4	EDL-RM-35-4	12
EDL5-NC-27-LPD	5	EDL-RM-35-4X	22
EDL5-NC-30-1	4	EDL-RM-40-4	12
EDL5-NC-30-LPD	5	EDL-SIC-27-4	15
EDL5-NC-35-1	4	EDL-SIC-30-4	15
EDL5-NC-40-1	4	EDL-SIC-35-4	15
EDL5-RM-27-1	4	EDL-SIC-40-4	15
EDL5-RM-27-LPD	5	EDLM-ADJ-27-3	26
EDL5-RM-30-1	4	EDLM-ADJ-30-3	26
EDL5-RM-30-LPD	5	EDLM-ADJ-35-3	26
EDL5-RM-35-1	4	EDLM-ADJ-40-3	26
EDL5-RM-40-1	4	EDLM-IC-27-3-LPD	27
EDL-ADJ-27-4	12	EDLM-IC-30-3-LPD	27
EDL-ADJ-30-4	12	EDLM-NC-27-3	26
EDL-ADJ-30-4X	22	EDLM-NC-27-3-LPD	27
EDL-ADJ-35-4	12	EDLM-NC-30-3	26
EDL-ADJ-35-4X	22	EDLM-NC-30-3-LPD	27
EDL-ADJ-40-4	12	EDLM-NC-35-3	26
EDL-ADJ-27-4-LPD	13	EDLM-NC-40-3	26
EDL-ADJ-30-4-LPD	13	EDLM-RM-27-3	26
EDL-NC-27-4	12	EDLM-RM-27-3-LPD	27
EDL-NC-27-4-LPD	13	EDLM-RM-30-3	26
EDL-NC-30-4	12	EDLM-RM-30-3-LPD	27
EDL-NC-30-4X	22	EDLM-RM-35-3	26
EDL-NC-30-4-LPD	13	EDLM-RM-40-3	26
EDL-NC-35-4	12		

## Trims & Accessories

EDL5-10-OPTIC -1	6	EDL-1003-4X	23	EDL-2101-4	17	EDLM-1400-3	30
EDL5-30-OPTIC -1	6	EDL-1004-4	16	EDL-2102-4	17	EDLM-1401-3	30
EDL5-50-OPTIC -1	6	EDL-1004-4X	23	EDL-2103-4	17	EDLM-1402-3	30
EDL5-80-OPTIC -1	6	EDL-1005-4	16	EDL-2200-4	17	EDLM-1501-3	31
EDL5-1000-1	8	EDL-1005-4X	23	EDL-2201-4	17	EDLM-1503-3	31
EDL5-1001-1	8	EDL-1006-4	16	EDL-3000-4	18	EDLM-1504-3	31
EDL5-1002-1	8	EDL-1006-4X	23	EDL-3000-4X	23	EDLM-1505-3	31
EDL5-1003-1	8	EDL-1007-4	16	EDL-3001-4	18	EDLM-1506-3	31
EDL5-1004-1	8	EDL-1007-4X	23	EDL-3001-4X	23	EDLM-1600-3	31
EDL5-1005-1	8	EDL-1100-4	16	EDL-3002-4	18	EDLM-1601-3	31
EDL5-1006-1	8	EDL-1100-4X	23	EDL-4000-4	19	EDLM-1602-3	31
EDL5-1100-1	8	EDL-1101-4	16	EDL-4001-4	19	EDLM-2001-3	29
EDL5-1101-1	8	EDL-1101-4X	23	EDL-4002-4	19	EDLM-2003-3	29
EDL5-1102-1	8	EDL-1102-4	16	EDL-5000-4	14	EDLM-2004-3	29
EDL5-1200-1	8	EDL-1102-4X	23	EDL-5001-4	14	EDLM-2005-3	29
EDL5-1700-1	6	EDL-1103-4	16	EDL-5002-4	14	EDLM-2100-3	29
EDL5-1701-1	6	EDL-1103-4X	23	EDL-5003-4	14	EDLM-2101-3	29
EDL5-1702-1	6	EDL-1200-4	16	EDL-5100-4	14	EDLM-2102-3	29
EDL5-1800-1	6	EDL-1200-4X	23	EDL-5101-4	14	EDLM-2200-3	29
EDL5-1801-1	6	EDL-1201-4	16	EDL-5102-4	14	EDLM-AT-GSKT	31
EDL5-1802-1	6	EDL-1201-4X	23	EDL-5103-4	14	EDLM-RD-FMA	31
EDL5-2000-1	9	EDL-1300-4	18	EDL-7000-4	14	EDLM-SQ-FMA	31
EDL5-2001-1	9	EDL-1301-4	18	EDL-7001-4	14	EL1	4, 12
EDL5-2002-1	9	EDL-1302-4	18	EDL-7002-4	14	EL2	4, 12
EDL5-2003-1	9	EDL-1303-4	18	EDL-7003-4	14	EM-1000	6, 14, 23, 31
EDL5-2004-1	9	EDL-1304-4	18	EDL-7100-4	14	EM-1002	6, 14, 31
EDL5-2100-1	9	EDL-1305-4	18	EDL-7101-4	14	L1	4, 12, 26
EDL5-2101-1	9	EDL-1306-4	18	EDL-7102-4	14	L2	4, 12
EDL5-2102-1	9	EDL-1307-4	18	EDL-7103-4	14	L3	4, 12
EDL5-2200-1	9	EDL-1400-4	18	EDL-AT-GSKT	14	L4	4, 12
EDL5-5000-1	6	EDL-1401-4	18	EDL-CL-4	14	LR1	26
EDL5-5001-1	6	EDL-1402-4	18	EDL-FT-4	14	RFLR-1000	23
EDL5-5002-1	6	EDL-1403-4	18	EDL-LN-4	14	RFLR-1001	23
EDL5-5003-1	6	EDL-1500-4	19	EDL-MHLDR-4	14	RFLR-1002	23
EDL5-5100-1	6	EDL-1501-4	19	EDL-MP-4	14		
EDL5-5101-1	6	EDL-1502-4	19	EDL-RD-FMA	14, 23		
EDL5-5102-1	6	EDL-1503-4	19	EDL-RD-TR-4	14		
EDL5-5103-1	6	EDL-1504-4	19	EDL-SQ-FMA	14		
EDL5-AT-GSKT	6	EDL-1505-4	19	EDLM-10-OPTIC-3	31		
EDL5-CL-1	6	EDL-1600-4	19	EDLM-30-OPTIC-3	31		
EDL5-FT-1	6	EDL-1601-4	19	EDLM-50-OPTIC-3	31		
EDL5-LN-1	6	EDL-1602-4	19	EDLM-80-OPTIC-3	31		
EDL5-MHLDR-1	6	EDL-1603-4	19	EDLM-1001-3	28		
EDL5-MP-1	6	EDL-1700-4	14	EDLM-1003-3	28		
EDL5-RD-FMA	6	EDL-1701-4	14	EDLM-1004-3	28		
EDL5-RD-TR-1	6	EDL-1702-4	14	EDLM-1005-3	28		
EDL5-SQ-FMA	6	EDL-1800-4	14	EDLM-1006-3	28		
EDL-10-OPTIC -4	14	EDL-1801-4	14	EDLM-1100-3	28		
EDL-30-OPTIC -4	14	EDL-1802-4	14	EDLM-1101-3	28		
EDL-50-OPTIC -4	14	EDL-2000-4	17	EDLM-1102-3	28		
EDL-80-OPTIC -4	14	EDL-2001-4	17	EDLM-1200-3	28		
EDL-1000-4	16	EDL-2002-4	17	EDLM-1301-3	30		
EDL-1001-4	16	EDL-2003-4	17	EDLM-1303-3	30		
EDL-1001-4X	23	EDL-2004-4	17	EDLM-1304-3	30		
EDL-1002-4	16	EDL-2005-4	17	EDLM-1305-3	30		
EDL-1003-4	16	EDL-2100-4	17	EDLM-1306-3	30		



A Division of Troy-CSL Lighting, Inc.

14508 Nelson Avenue  
City of Industry CA 91744  
Tel: 626.336.4511  
Fax: 626.330.4266

[www.csllighting.com](http://www.csllighting.com)



C-CECOD03-16



782042158030

